



# Service Facts

## ComfortLink™ II System Cooling 4TTX6060C1000A

**IMPORTANT** — This document contains a wiring diagram, a parts list, and service information. This is customer property and is to remain with this unit. Please return to service information pack upon completion of work.

**⚠ WARNING: HAZARDOUS VOLTAGE - DISCONNECT POWER and DISCHARGE CAPACITORS BEFORE SERVICING**

**⚠ CAUTION**  
**UNIT CONTAINS R-410A REFRIGERANT!**  
 R-410A OPERATING PRESSURE EXCEEDS THE LIMIT OF R-22. PROPER SERVICE EQUIPMENT IS REQUIRED. FAILURE TO USE PROPER SERVICE TOOLS MAY RESULT IN EQUIPMENT DAMAGE OR PERSONAL INJURY.  
**SERVICE**  
 USE ONLY R-410A REFRIGERANT AND APPROVED POE COMPRESSOR OIL.

### PRODUCT SPECIFICATIONS

<b>OUTDOOR UNIT</b> ①②	<b>4TTX6060C1000A</b>
<b>POWER CONNS.</b> — V/PH/HZ ③	230/1/60
MIN. BRCH. CIR. AMPACITY	35
BR. CIR. PROT. RTG. — MAX. (AMPS)	60
<b>COMPRESSOR</b>	CLIMATUFF® - SCROLL
NO. USED - NO. STAGES	1 - 2
VOLTS/PH/HZ	230/1/60
R.L. AMPS ⑦ - L.R. AMPS	25.6 - 118
FACTORY INSTALLED	
START COMPONENTS ⑧	YES
INSULATION/SOUND BLANKET	YES
COMPRESSOR HEAT	YES
<b>OUTDOOR FAN</b>	PROPELLER
DIA. (IN.) - NO. USED	27.6 - 1
TYPE DRIVE - NO. SPEEDS	DIRECT - 1
CFM @ 0.0 IN. W.G. ④	4400/4400
NO. MOTORS - HP	1 - 1/3
MOTOR SPEED R.P.M.	850
VOLTS/PH/HZ	200/230/1/60
F.L. AMPS	2.80
<b>OUTDOOR COIL</b> — TYPE	SPINE FIN™
ROWS - F.P.I.	2 - 24
FACE AREA (SQ. FT.)	26.32
TUBE SIZE (IN.)	5/16
REFRIGERANT CONTROL	N/A
<b>REFRIGERANT</b>	R-410A
LBS. — R-410A (O.D. UNIT) ⑤	11 LBS. - 3 OZ.
FACTORY SUPPLIED	YES
LINE SIZE - IN. O.D. GAS ⑥	7/8
LINE SIZE - IN. O.D. LIQ. ⑥	3/8
<b>CHARGING SPECIFICATION</b>	
SUBCOOLING	See Charging Chart (page 3)
<b>DIMENSIONS</b>	H X W X D
CRATED (IN.)	53.4 X 35.1 X 38.7
<b>WEIGHT</b>	
SHIPPING (LBS.)	361
NET (LBS.)	313

### TUBING INFORMATION

Tubing Sizes		Tubing Length	Additional Refrigerant
Suction	Liquid		
7/8"	3/8"	20'	3 oz.
7/8"	3/8"	30'	9 oz.
7/8"	3/8"	40'	16 oz.
7/8"	3/8"	50'	22 oz.
7/8"	3/8"	60'	28 oz.

Tubing lengths in excess of sixty (60) feet see application software.

- ① Certified in accordance with the Air-Source Unitary Air-conditioner Equipment certification program, which is based on ARI standard 210/240. In order to achieve ARI standard rating, the indoor fan time delay on the comfort control must be enabled.
- ② Rated in accordance with ARI standard 270.
- ③ Calculated in accordance with Natl. Elec. Codes. Use only HACR circuit breakers or fuses.
- ④ Standard Air — Dry Coil — Outdoor
- ⑤ This value approximate. For more precise value see unit nameplate.
- ⑥ Max. linear length 60 ft.; Max. lift - Suction 25 ft.; Max. lift - Liquid 25 ft. For greater length consult refrigerant piping software Pub. No. 32-3312-0\* (\* denotes latest revision).
- ⑦ This value shown for compressor RLA on the unit nameplate and on this specification sheet is used to compute minimum branch circuit ampacity and max. fuse size. The value shown is the branch circuit selection current.
- ⑧ No means no start components. Yes means quick start kit components. PTC means positive temperature coefficient starter.

**⚠ CAUTION**  
**HOT SURFACE!**  
**DO NOT TOUCH TOP OF COMPRESSOR.**  
 May cause minor to severe burning.

**⚠ CAUTION**  
**CONTAINS REFRIGERANT!**  
**SYSTEM CONTAINS OIL AND REFRIGERANT UNDER HIGH PRESSURE. RECOVER REFRIGERANT TO RELIEVE PRESSURE BEFORE OPENING SYSTEM.**  
 Failure to follow proper procedures can result in personal illness or injury or severe equipment damage.

### ⚠ WARNING

THIS INFORMATION IS INTENDED FOR USE BY INDIVIDUALS POSSESSING ADEQUATE BACKGROUNDS OF ELECTRICAL AND MECHANICAL EXPERIENCE. ANY ATTEMPT TO REPAIR A CENTRAL AIR CONDITIONING PRODUCT MAY RESULT IN PERSONAL INJURY AND OR PROPERTY DAMAGE. THE MANUFACTURER OR SELLER CANNOT BE RESPONSIBLE FOR THE INTERPRETATION OF THIS INFORMATION, NOR CAN IT ASSUME ANY LIABILITY IN CONNECTION WITH ITS USE.

### ⚠ CAUTION

RECONNECT ALL GROUNDING DEVICES.  
 ALL PARTS OF THIS PRODUCT CAPABLE OF CONDUCTING ELECTRICAL CURRENT ARE GROUNDED. IF GROUNDING WIRES, SCREWS, STRAPS, CLIPS, NUTS OR WASHERS USED TO COMPLETE A PATH TO GROUND ARE REMOVED FOR SERVICE, THEY MUST BE RETURNED TO THEIR ORIGINAL POSITION AND PROPERLY FASTENED.

**NOTICE:** The manufacturer has a policy of continuous product and product data improvement and reserves the right to change design and specifications without notice.

**SCHEMATIC DIAGRAM**

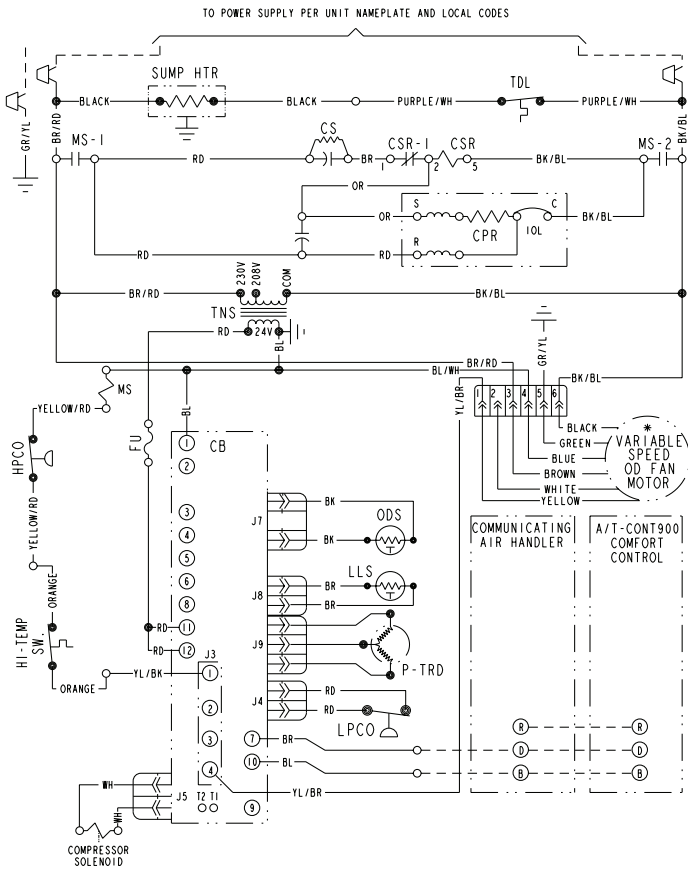

CA COOLING ANTICIPATOR	LPCO LOW PRESSURE CUTOUT SW.
CB CONTROL BOARD	MS COMPRESSOR MOTOR CONTACTOR
CBS COIL BOTTOM SENSOR	ODS OUTDOOR ANTICIPATOR
CF FAN CAPACITOR	OFT OUTDOOR FAN THERMOSTAT
CN WIRE CONNECTOR	ODS OUTDOOR TEMPERATURE SENSOR
CPR COMPRESSOR	ODT OUTDOOR THERMOSTAT
CR RUN CAPACITOR	P-TRD PRESSURE TRANSDUCER
CS STARTING CAPACITOR	RHS RESISTANCE HEAT SWITCH
CSR CAPACITOR SWITCHING RELAY	SC SWITCHOVER VALVE SOLENOID
DFC DEFROST CONTROL	SM SYSTEM "ON-OFF" SWITCH
F INDOOR FAN RELAY	TDL DISCHARGE LINE THERMOSTAT
HA HEATING ANTICIPATOR	TNS TRANSFORMER
HPCO HIGH PRESSURE CUTOUT SW.	TS HEATING-COOLING THERMOSTAT
IOL INTERNAL OVERLOAD PROTECTOR	TSH HEATING THERMOSTAT
LLS LIQUID LINE SENSOR	

**WARNING**  
HAZARDOUS VOLTAGE!  
DISCONNECT ALL ELECTRIC POWER INCLUDING REMOTE DISCONNECTS BEFORE SERVICING.  
FAILURE TO DISCONNECT POWER BEFORE SERVICING CAN CAUSE SEVERE PERSONAL INJURY OR DEATH!

**CAUTION**  
USE COPPER CONDUCTORS ONLY! UNIT TERMINALS ARE NOT DESIGNED TO ACCEPT OTHER TYPES OF CONDUCTORS.  
FAILURE TO DO SO MAY CAUSE DAMAGE TO THE EQUIPMENT!

- △ COLOR OF WIRE  
BK/BL BLACK WIRE WITH BLUE MARKER  
OR COLOR OF MARKER
- BK BLACK OR ORANGE YL YELLOW  
BL BLUE RD RED GR GREEN  
BR BROWN WH WHITE PR PURPLE
- NOTES:  
1. LOW VOLTAGE (24 V.) FIELD WIRING MUST BE 18 AWG MIN.  
2. FOR 208V OPERATION, SWAP BR/RD TRANSFORMER LEAD AND INSULATED CAP ON 208V CENTER TRANSFORMER TERMINAL.

**CHARGING METHOD**

This model has ComfortLink™ II and Charge Assist™ features. Charge Assist™ can be used in cooling mode only.

For complete instructions on using Charge Assist™ please see page 4.

**MANUAL CHARGING BELOW 55°F OD AMBIENT – IN HEATING MODE (HP MODELS ONLY)**

1. The only recommended method of charging at outdoor ambients below 55°F, is to weigh in the charge in the heating mode.
2. Check liquid line temperature and pressure (at the OD valves) to obtain a minimum of 10°F subcooling.
3. It is important to return in the spring or summer to accurately charge the system in the cooling mode at outdoor ambients from 55°F-120°F.

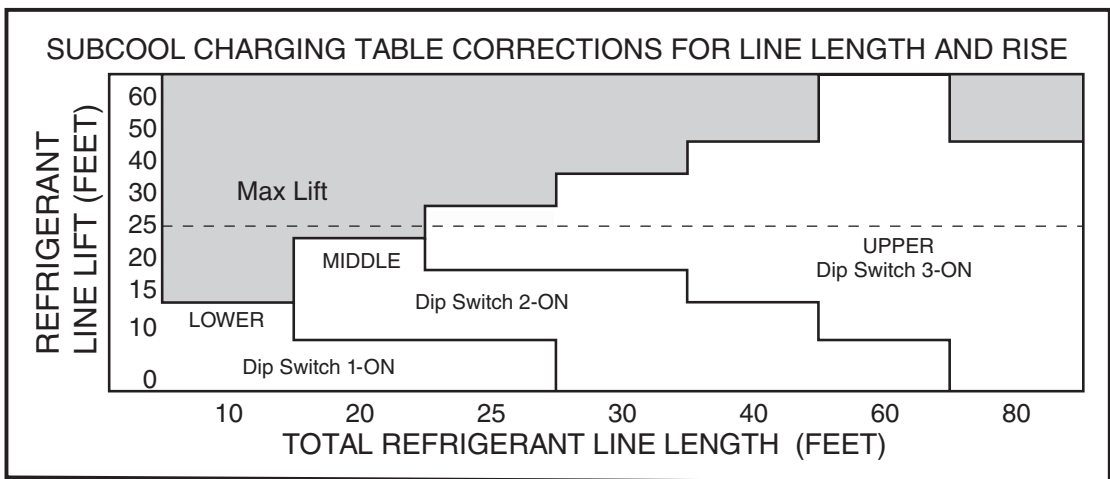

WIRING DIAGRAM

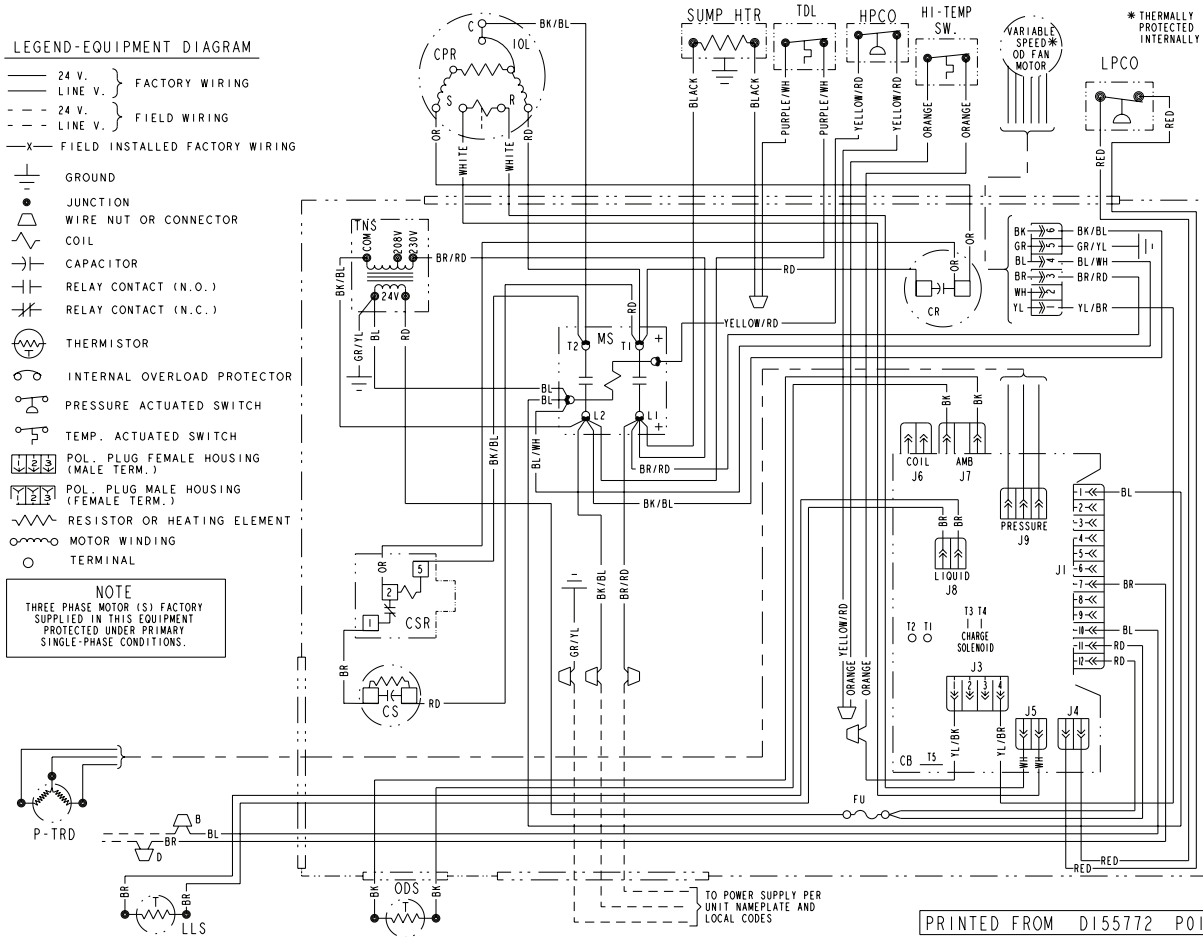

**MANUAL CHARGING OR CHARGE ASSIST™ METHOD IN COOLING BETWEEN 55°F AND 120°F OD AMBIENT**

Trane recommends installing Trane approved matched indoor and outdoor systems.

All Trane split systems are ARI rated with only TXV indoor systems.

The benefits of installing approved indoor and outdoor split systems are maximum efficiency, optimum performance and the best overall system reliability. The following charging methods are therefore prescribed for matched systems with indoor TXVs.

- Subcooling using the R-410A Refrigerant Charging Chart (in the cooling mode) is the only recommended method of charging between 55°F and 120°F ambient temperatures.
- When charging for ambient temperatures above 120°F, charge to 10° subcooling. It is important to return when outdoor ambient temperature is between 55°F and 120°F to verify system charge per these instructions.
- For best results – the indoor temperature should be kept between 70°F to 80°F. Add system heat if needed.
- At startup, or whenever charge is removed or added, the system must be operated for a minimum twenty (20) minutes to stabilize before accurate measurements can be made. (Feature of Charge Assist™)
- Measure Liquid Line Temperature and Refrigerant Pressure at service valves. (Not required with Charge Assist.™)
- Determine total refrigerant line length, and height (lift) if indoor section is above the condenser. Set dip switches on Charge Assist™ board as indicated in the Subcool Charging Corrections Table on page 2.
- Locate your liquid line temperature in the left column of the table, and the intersecting liquid line gage pressure under the DIPSWITCH selection column. Add refrigerant to raise the pressure to match the table, or remove refrigerant to lower the pressure. For manual charging, always wait twenty (20) minutes for the system conditions to stabilize before adjusting charge again. (Not required with Charge Assist.™)
- Charge Assist port is designed for liquid refrigerant charging.
- When system is correctly charged, you can refer to System Pressure Curves (on page 8) to verify typical performance.

R410A REFRIGERANT CHARGING CHART			
LIQUID TEMP (°F)	LIQUID GAGE PRESSURE (PSIG)		
	DIPSWITCH 1	DIPSWITCH 2	DIPSWITCH 3
	LOWER	MIDDLE*	UPPER
55	189	191	192
60	200	203	204
65	212	217	218
70	227	232	235
75	244	249	253
80	263	269	275
85	285	292	298
90	308	317	323
95	334	344	351
100	362	374	381
105	392	407	414
110	425	442	448
115	459	479	485
120	496	519	524
125	535	561	566

\* Data is based on 11.7° of subcooling at a 95° ambient  
Printed from D155829P05 REV1

# Charge Assist™ (CA) Procedure with a Communicating Comfort Control

## ⚠ CAUTION

### CONTAINS REFRIGERANT!

SYSTEM CONTAINS OIL AND REFRIGERANT UNDER HIGH PRESSURE. RECOVER REFRIGERANT TO RELIEVE PRESSURE BEFORE OPENING SYSTEM.

Failure to follow proper procedures can result in personal illness or injury or severe equipment damage.

**NOTE:** On the Charge Assist™ control set the LINE LENGTH DIP SWITCHES before running system or entering CA Mode. See Subcool Charging Corrections Table on page 2.

The Communicating Comfort Control will auto-configure the system size and airflow requirement at power-up. The Charge Assist™ (CA) Mode will set the indoor blower to 100%, override any blower delays and run compressor 2nd stage. (Green LEDs Y1 and Y2 will be on. The Green Status LED will be turned off.)

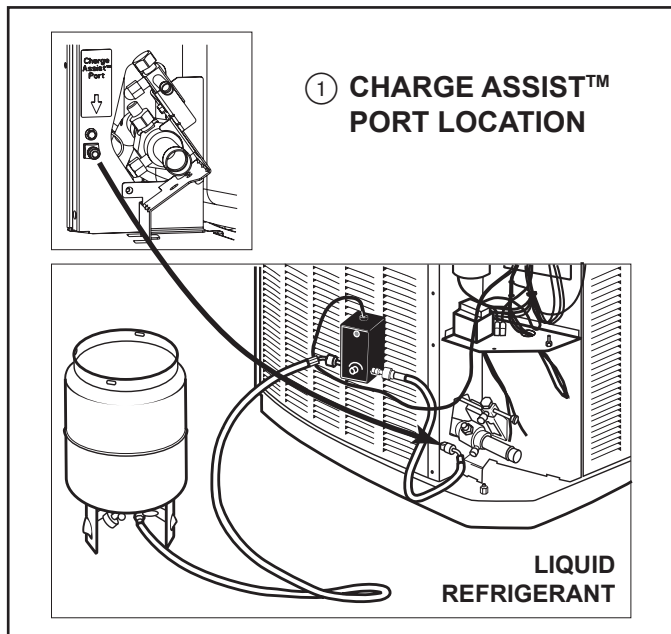

## Procedure

### STEP 1:

Press **MODE** button (See Figure 2) for 2 seconds to enter the CA mode. The CA control takes control of the system and overrides the Communicating Comfort Control. The **Green STATUS** LED is turned OFF. The CA control will run the first stage compressor for one minute. Green LED Y1 is on. The CA control will then run the second stage compressor. Green LEDs Y1 and Y2 will then be ON. The CA control now starts its Charge Assist™ mode. The CA control will now check the operating Conditions before continuing the CA Mode.

**NOTE:** To stop the CA mode at anytime, press the **MODE** button. The CA control will then begin slowly flashing its Green **STATUS** LED indicating that the CA control is now in its normal operating mode.

## ⚠ WARNING

### Live Electrical Components!

During installation, testing, servicing and troubleshooting of this product, it may be necessary to work with live electrical components. Failure to follow all electrical safety precautions when exposed to live electrical components could result in death or serious injury.

**Outdoor Temperature (ODT)** Must be between 55°F and 120°F. If ODT is below 55°F or above 120°F, the **ODT, OUT OF RANGE**, Red LED will flash ON and OFF for 30 seconds. This error condition causes the **CHARGING (STABILIZING)** Amber LED to flash 10 times. The CA control will then exit the CA mode and the Green **Status** LED begins to flash slowly.

**Liquid Line Temperature** (Must be within range) If this sensor is shorted or open - This error condition causes an 11 flash on **FAULT** LED.

**Liquid Line Pressure** (Must be above 90 psig) If the liquid pressure is below 90 psig, the **LOW PRESSURE** Red LED will turn on for 30 seconds. This error condition causes the CA control to flash its **CHARGING (STABILIZING)** Amber LED 10 times. The CA control will then exit the CA mode and it then begins flashing its Green **Status** LED slowly.

### STEP 2:

**Enter Stabilization Routine** The **CHARGING (STABILIZING)** Amber LED will begin to flash.

The CA control will then indicate the time it will take for the refrigerant system to stabilize by flashing its **CHARGING (STABILIZING)** Amber LED. (See SUMMARY on page 7 for flash rate details.)

The CA control may run the system for up to twenty minutes to insure the refrigerant system is at a steady operating state. Once the system is at a steady operating state the CA control will enter the **Charging Routine**.

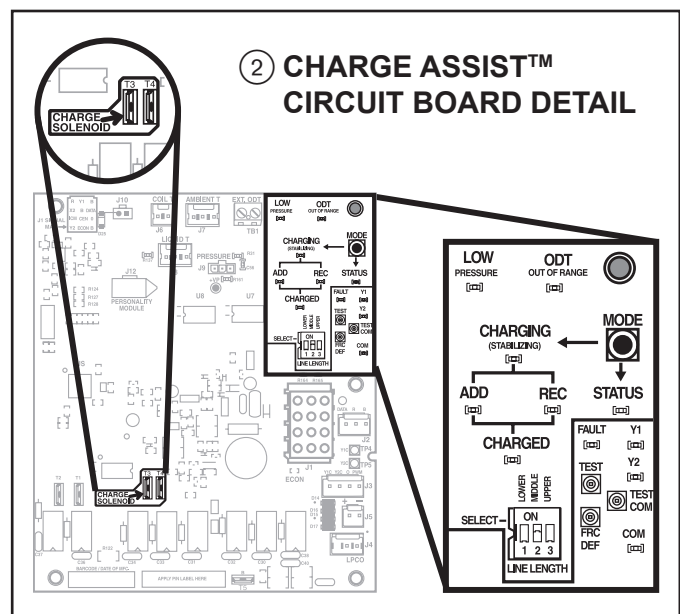

**STEP 3:**

**CHARGING Routine**

Charge Assist™ will follow one of the following routines.

	STABILIZING LED	CHARGED LED	ADD LED	REC LED
CHARGED Routine (See Step 4)	OFF	ON	OFF	OFF
ADD Routine (See Step 5)	OFF	Flashing	ON	OFF
RECOVER Routine (See Step 6)	OFF	OFF	OFF	ON

**STEP 4:**

**CHARGED Routine**

IF the CA control determines the system is correctly charged, the CHARGING (STABILIZING) Amber LED will be turned OFF and the CHARGED Green LED will be turned ON.

The CA control will then exit the charge assist cycle and return the control of the system to the Communicating Comfort Control. The Status Green LED will be slowly flashing. The CHARGED Green LED will stay ON for 1 hour.

**STEP 5:**

**ADD Routine** If the CA control determines refrigerant is required, the ADD Amber LED will turn ON and the Green CHARGED LED will begin FLASHING according to the CHARGED Green LED flash Rate Schedule.

(See SUMMARY on page 7 for flash rate details.)

**NOTE:** For Automated charging, use BAYCAKT001AA. When utilizing a Charging accessory Solenoid Kit (BAYCAKT001-shown in Figure 3) refer to the instructions in the kit (18-HH15D1-\*) for proper hook up. When the Amber ADD LED is ON the CA control board provides a 24 VAC power for the accessory solenoid. The CA control will turn off the 24 VAC power when the Amber ADD LED goes off.

When refrigerant is being added, the CA control will exit the Charge Assist™ cycle if the liquid line pressure **does not increase by 4 psi in 50 minutes** or if the liquid line pressure **does not get within the 20 psi of the required charged pressure within 1 hour**.

**Note: For Manual Charging**

Once sufficient charge has been added, the Amber ADD LED will turn OFF and the Green CHARGED LED will be turned ON. When the Amber ADD LED turns OFF; **stop adding refrigerant**. The Green CHARGED LED will stay on for 5 minutes while the unit runs. The CA control will now exit the Charge Assist™ cycle and returns control to the Communicating Comfort Control.

③ **Charge Assist™ Solenoid Kit BAYCAKT001**

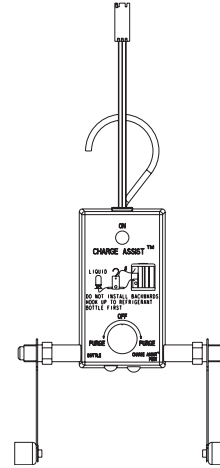

**Use for Auto Charging**  
(See Installer's Guide 18-HH15D1-\*)

**STEP 6:**

**RECOVER Routine**

If the CA control determines there is excessive refrigerant in the system, the REC Red LED will be turned ON. The CA control will lock the system off for one hour and it will then exit the CA cycle. The REC Red LED will stay ON for 1 hour. The CA control lock out period can be stopped by pressing the MODE button for 2 seconds. Status LED will be off during lockout.

**NOTE: Personality Module (PM)** contains model specific information needed for system operation - **Do Not Remove**.

**NOTE:** The word 'Wait' will be displayed on the Communicating Comfort Control when the system is in the CA mode. The Communicating Comfort Control does not control the system operation when the system is running in the CA Mode. Any changes in the Communicating Comfort Control programming made during the CA mode of operation will become effective after the CA mode ends.

**NOTE:** Charge Assist™ **IS NOT** allowed when a heat pump is operating in the heating cycle. If the mode button is pressed during an active compressor heat call, the CHARGING (STABILIZING) LED will flash 10 times indicating that CA is not allowed. Once an active call for compressor heat has ended, CA may be entered.

**CAUTION:** Minimum equipment off time is bypassed during Charge Assist™. Avoid cycling compressor quickly. Observe the recommended 5-minute minimum off time for compressor protection.

# Charge Assist™ (CA) Procedure for a NON-Communicating 24VAC Control System

## STEP 1:

Outdoor units coupled with 24 volt indoor units (outdoor units require BAYACHP024\* for 24V operation) require the technician to set up the Variable Speed (VS) Air Handler or VS Furnace with the DIP switches for the size of the equipment installed. (Unit tonnage, CFM per ton 350, 400, 450 required, the blower delays and Heating airflow) CA cycle is compatible with ENHANCED Mode.

## STEP 2:

A technician must set the indoor system control to call for the **SECOND STAGE of COOLING**. The indoor **CONTROL** must be **set low enough** to ensure the system continues to run in **SECOND STAGE of COOLING** throughout the CA mode cycle. The CA control will exit the **CA mode CYCLE** if the system control does not stay in the SECOND STAGE cooling cycle. (The CA Control must see 24 Volts AC call on both Y1 and Y2.)

## STEP 3:

Press the mode button on the **CA** board and follow the **CA** procedures starting with **STEP 1** in the **Communicating Comfort Control Section** above.

## STEP 4:

After the **CA** control exits the **CA mode CYCLE**, the technician must then return the NON-COMMUNICATING 24 volt indoor CONTROL to the desired customer setting.

## SUMMARY OF ALERT CODE & CHARGE ASSIST™ LEDS

LED Color	Fault LED	Alert Code	Description	Control Display	LED Color	Charge Assist™ (CA) LEDs	Description		
Red	1 Flash	90	Excessive Communication Errors	N/A	Green	CHARGED	Flashing	See Charging Flash Rate	
		91	Loss of Heat/Cool Demand Message (COMM)	ERR 91			Off	Charged or not in CA Mode	
	Loss of Bit Master (Clock Signal)		On				Charge is Correct		
	2 Flash	68	Defrost Fault A	N/A			Y1	On	1st stage compressor requests
	3 Flash		Defrost Fault B and/or C			Y2	On	2nd stage compressor request	
	4 Flash		Defrost Fault A and [B and/or C]			STATUS	Fast Flash	Initialization at Power Up ~ 60 seconds	
	5 Flash	67	Ambient Temperature Sensor Fault (Out of Range - Open or Shorted)	Med Flash			Oil Return Mode ** (Forced Defrost)		
	6 Flash		Coil Temperature Sensor Fault (Out of Range - Open or Shorted)	Slow Flash			Standard operation		
	7 Flash	79	Low Pressure Cut Out Fault (Open outside of defrost Cycle-Hard lock out, cycle power to reset)	ERR 79			Off	Charge Assist™ mode or no power to control	
			Low Pressure Cut Out Fault Heat/Cool Lock out			Wait ☐	LitePort	Occasional Flash	For transmitting LitePort™ data
	10 Flash	102	Y2 without Y1 - Miswire (24 volt mode only)	N/A				Amber	COM
	11 Flash	67	Liquid Temperature Sensor Fault (Out of Range - Open or Shorted)	N/A		Off	No power		
	12 Flash	113	Liquid Pressure Sensor Fault (Out of Range - Open or Shorted)	ERR 113		On	Solid at power-up		
	13 Flash	67	External Outdoor Temperature Sensor Fault (Out of Range - Shorted)	N/A		CHARGING	Flashing		See Stabilization Flash Rate
	14 Flash	114	PM Missing with local copy (Operational)	ERR 114			Off	Not in CA Mode	
			Bad Data in PM with local copy (Operational)	N/A		ADD	On	System requires refrigerant charge (Control has 24 volt AC output to Charge Solenoid)	
			Bad Data in PM no local copy (Not Operational)	ERR 114			ODT	Flashing	Ambient Temperature is out of range - Ambient Temperature must be above 55°F and below 120°F to enter CA Mode <b>Note:</b> ODT LED will flash 1 sec ON/OFF for 30 seconds and the CHARGING LED will flash 5 times per second for 2 seconds, then exit CA.
			PM Missing with no local copy (Not Operational)			RECOVER		On	Need to recover refrigerant - Unit locked out for 1 hour or press mode button to exit Charge Assist™
15 Flash *	50	Duplicate OD Temperature Sensor *	N/A	LOW	On		Liquid pressure below 90 psig - Liquid pressure must be above 90 psig to enter CA Mode <b>Note:</b> LOW pressure LED will be on for 30 seconds and the CHARGING LED will flash 5 times per second for 2 seconds, then exit CA.		
16 Flash *	123	Demand Configuration Fault *	N/A		Notes: ** Used with 20 SEER Models				
17 Flash	80	High Pressure Monitor Fault (Hard lock out, cycle power to reset)	ERR 80						
		High Pressure Monitor Fault (Short lock out)	Wait ☐						
18 Flash	18	24V Sensing Error (24V Missing at Y1)	ERR 18						
<b>Notes:</b> 4 highest priority Faults display flash codes sequentially. 2 second pause between faults and 4 second pause between sequences. Cycle power to ODU to clear Faults. * Alert flash code will not be implemented for initial release ☐ Wait icon will appear on the Comfort Control during: Equipment minimum off time, Charge Assist, Short lock out (see Alert Codes "7 Flash" & "17 Flash")									



# TROUBLESHOOTING

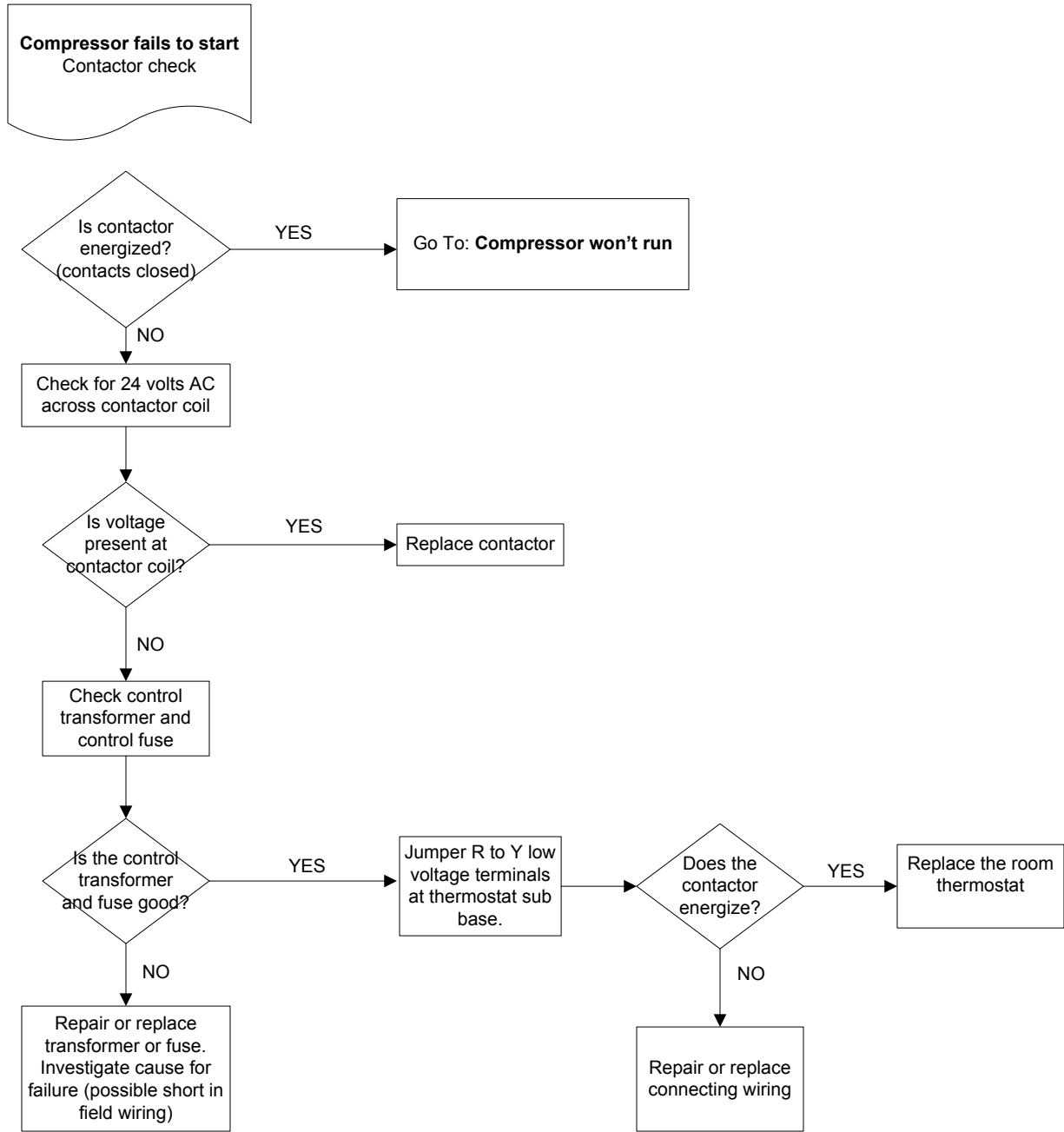

**Single Pole Contactor (MS)\***

**Double Pole Contactor (MS)\***

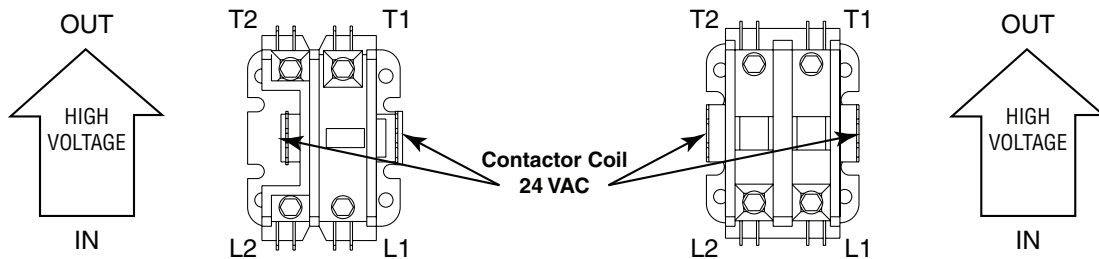

\*Refer to Wiring Diagram to determine if a single pole or double pole contactor is used.

# TROUBLESHOOTING

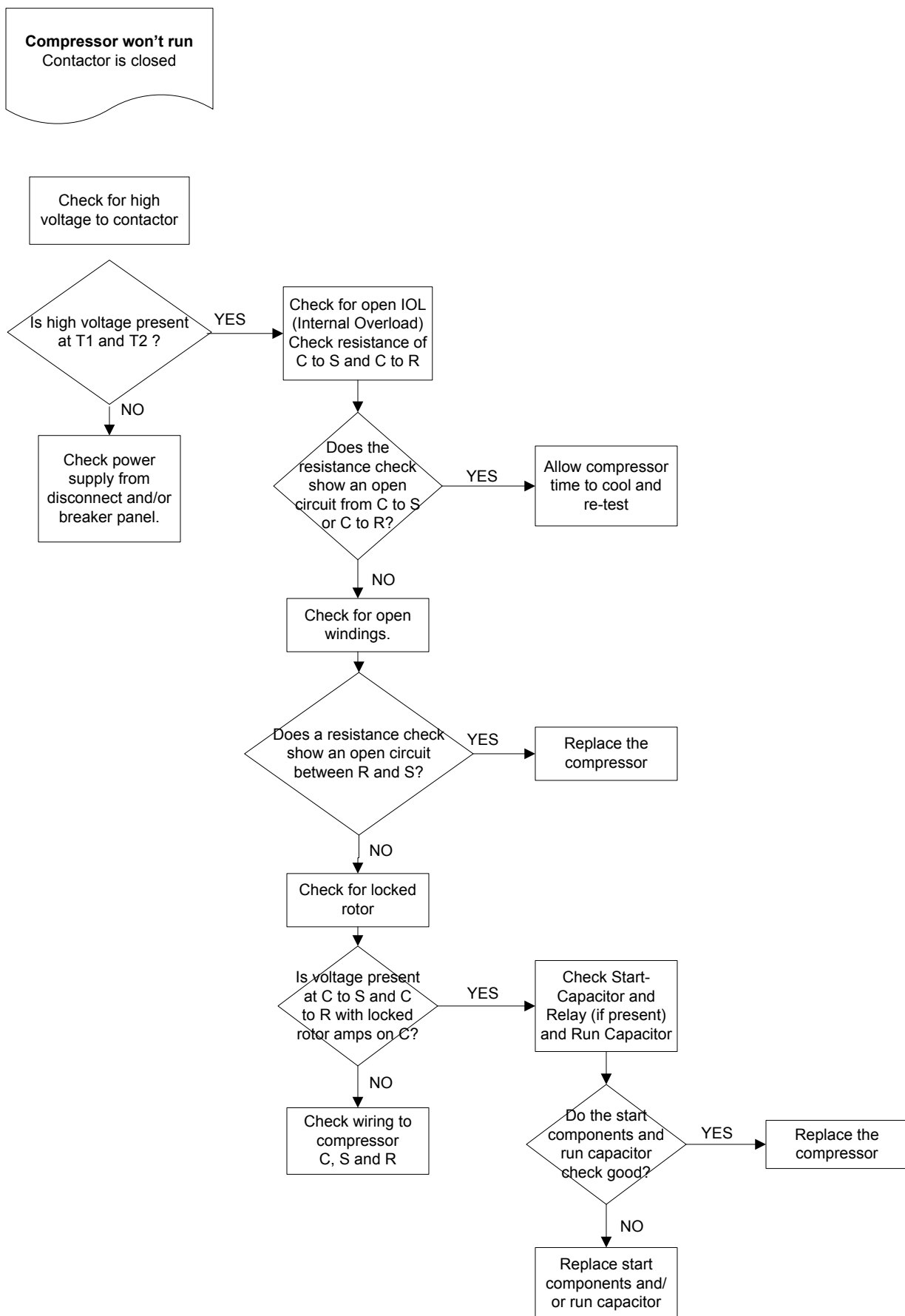

# CONTROL BOARD TEST POINTS

Test DC voltages at the locations shown below. Corresponding tables show proper values or ranges.

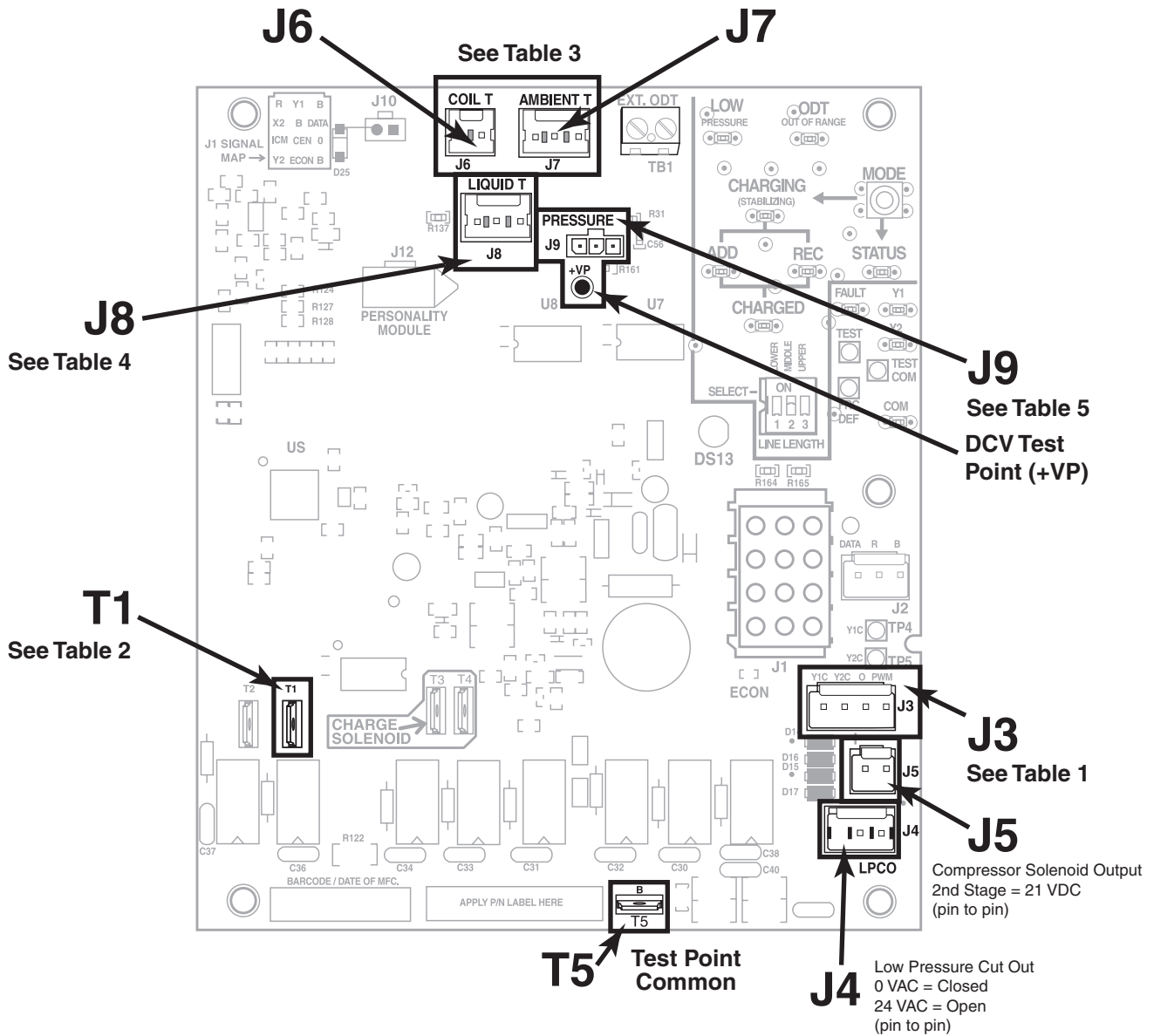

## Outdoor Fan Motors

TABLE 1

3 & 5 Ton Units (ECM Motors) - J3	
Cooling & Heating Speed	Volts DC at plug J3-PWM (to test point common)
High Stage	7 to 10

TABLE 2

2 & 4 Ton Units (PSC Motors) - T1	
Cooling & Heating Speed	Volts AC at plug T1 (to test point common)
High Stage	24V to ODF-1

**TABLE 3**  
Ambient and Coil Sensors - J6, J7

Temp °F	Temp °C	THERMISTOR RESISTANCE (OHMS)	Volts DC at plug J6 & J7 Only (pin to pin)
0	-17.8	83247	3.29
5	-15.0	71108	3.11
10	-12.2	60916	2.93
15	-9.4	52333	2.74
20	-6.7	45076	2.55
25	-3.9	38927	2.37
30	-1.1	33703	2.19
35	1.7	29253	2.02
40	4.4	25452	1.85
45	7.2	22198	1.70
50	10.0	19405	1.55
55	12.8	17002	1.41
60	15.6	14930	1.28
65	18.3	13138	1.17
70	21.1	11586	1.06
75	23.9	10238	0.96
80	26.7	9065	0.87
85	29.4	8043	0.78
90	32.2	7150	0.71
95	35.0	6368	0.64
100	37.8	5682	0.58
105	40.6	5079	0.53
110	43.3	4548	0.48
115	46.1	4079	0.43
120	48.9	3665	0.39
125	51.7	3298	0.35
130	54.4	2972	0.32
135	57.2	2683	0.29
140	60.0	2425	0.27
145	62.8	2195	0.24
150	65.6	1990	0.22

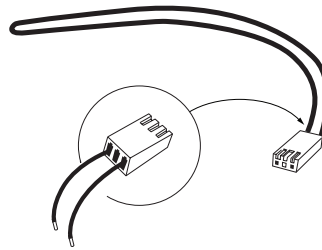

Ambient Sensor

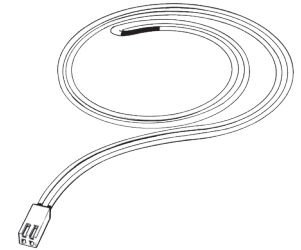

Coil Sensor

**TABLE 5**  
Liquid Line  
Pressure Transducer - J9  
Voltage to pressure reference chart

Pressure (PSIG)	Volts DC at plug J9 Test Point (+VP) (to test point common)
30	0.66
60	0.83
90	1.00
120	1.18
150	1.35
180	1.52
210	1.69
240	1.86
270	2.03
300	2.21
330	2.38
360	2.55
390	2.72
420	2.89
450	3.06
480	3.23
510	3.41
540	3.58
570	3.75
600	3.92
630	4.09
660	4.26

**TABLE 4**  
Liquid Line Temperature Sensor - J8

Temp °F	Temp °C	THERMISTOR RESISTANCE (OHMS)	Volts DC at plug J8 Only (pin to pin)
50	10.0	19405	2.22
55	12.8	17002	2.06
60	15.6	14930	1.90
65	18.3	13138	1.75
70	21.1	11586	1.61
75	23.9	10238	1.48
80	26.7	9065	1.36
85	29.4	8043	1.24
90	32.2	7150	1.14
95	35.0	6368	1.04
100	37.8	5682	0.95
105	40.6	5079	0.86
110	43.3	4548	0.79
115	46.1	4079	0.72
120	48.9	3665	0.66
125	51.7	3298	0.60

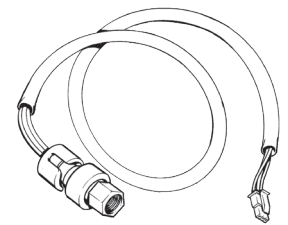

Liquid Line Pressure Transducer

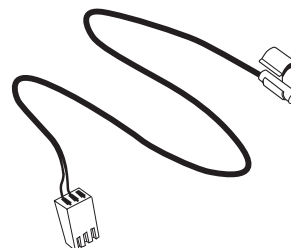

Liquid Line Temperature Sensor

**PRESSURE CURVES FOR 4TTX6060C1000AA**

**FIRST STAGE**

**4TEE3F65A**

Cooling with Thermal Expansion Valve

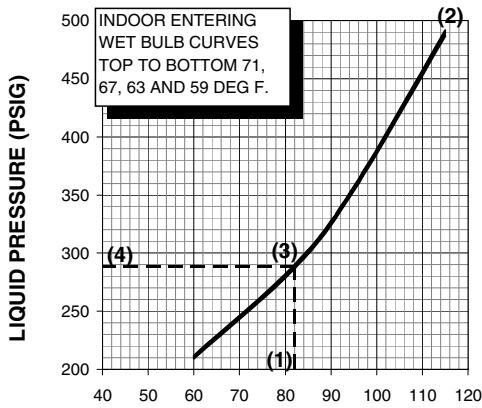

**SECOND STAGE**

**4TEE3F65A**

Cooling with Thermal Expansion Valve

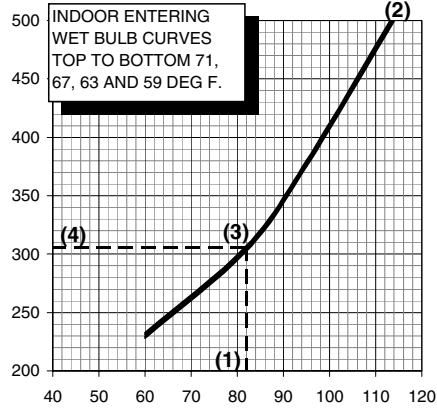

**OUTDOOR TEMPERATURE (Degree F)**

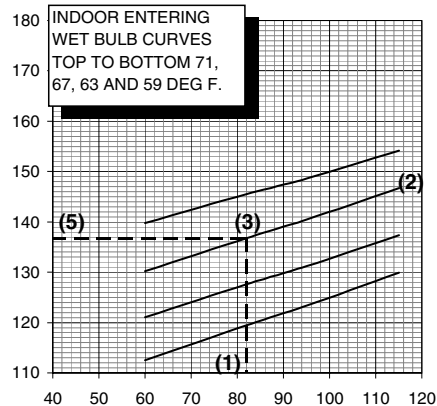
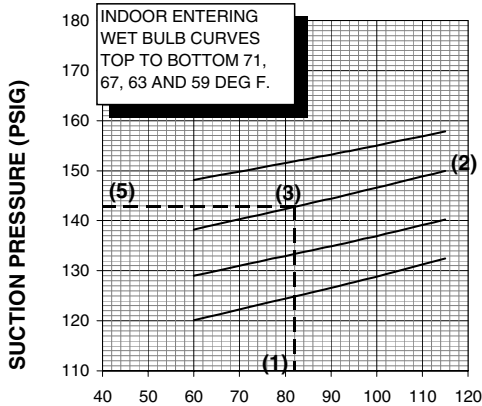

**OUTDOOR TEMPERATURE (Degree F)**

COOLING PERFORMANCE CAN BE CHECKED WHEN THE OUTDOOR TEMP IS ABOVE 65 DEG F.

TO CHECK COOLING PERFORMANCE, SELECT THE PROPER INDOOR CFM, ALLOW PRESSURES TO STABILIZE. MEASURE INDOOR WET BULB TEMPERATURE, OUTDOOR TEMPERATURE, LIQUID AND SUCTION PRESSURES. ON THE PLOTS LOCATE OUTDOOR TEMPERATURE (1); LOCATE INDOOR WET BULB (2); FIND INTERSECTION OF OD TEMP. & ID W.B. (3); READ LIQUID (4) OR SUCTION (5) PRESSURE IN LEFT COLUMN.

**EXAMPLE: FIRST STAGE**

- (1) OUTDOOR TEMP. 82 F.
- (2) INDOOR WET BULB 67 F.
- (3) AT INTERSECTION
- (4) LIQUID PRESSURE @ 1260 CFM IS 289 PSIG
- (5) SUCTION PRESSURE @ 1260 CFM IS 143 PSIG

**EXAMPLE: SECOND STAGE**

- (1) OUTDOOR TEMP. 82 F.
- (2) INDOOR WET BULB 67 F.
- (3) AT INTERSECTION
- (4) LIQUID PRESSURE @ 1750 CFM IS 305 PSIG
- (5) SUCTION PRESSURE @ 1750 CFM IS 137 PSIG

INTERCONNECTING LINES  
GAS - 7/8" O.D.  
LIQUID - 3/8" O.D.

**ACTUAL:**

LIQUID PRESSURE SHOULD BE +/- 10 PSI OF CHART  
SUCTION PRESSURE SHOULD BE +/- 3 PSIG OF CHART

DWG.NO. 4TTX6060C1



ARI Standard  
210/240 UAC



Trane  
www.trane.com

Trane has a policy of continuous product and product data improvement and it reserves the right to change design and specifications without notice.